

Water Connections use 1/2" FIP:
On back corner panel
50" above the floor

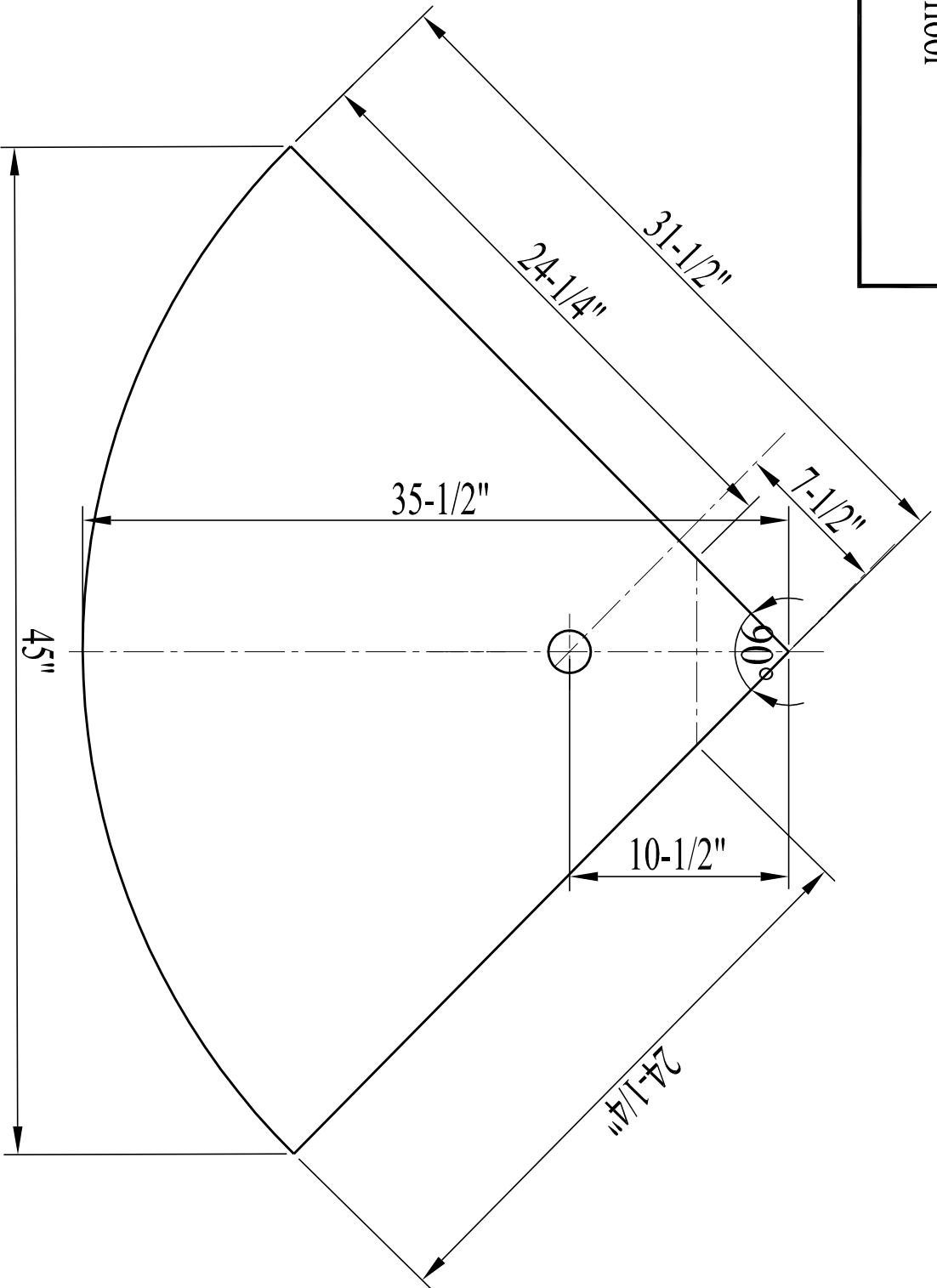

S-3232

A.H.Funrico.Inc