

Water Connections use 1/2" FIP:
On back corner panel
59" above the floor

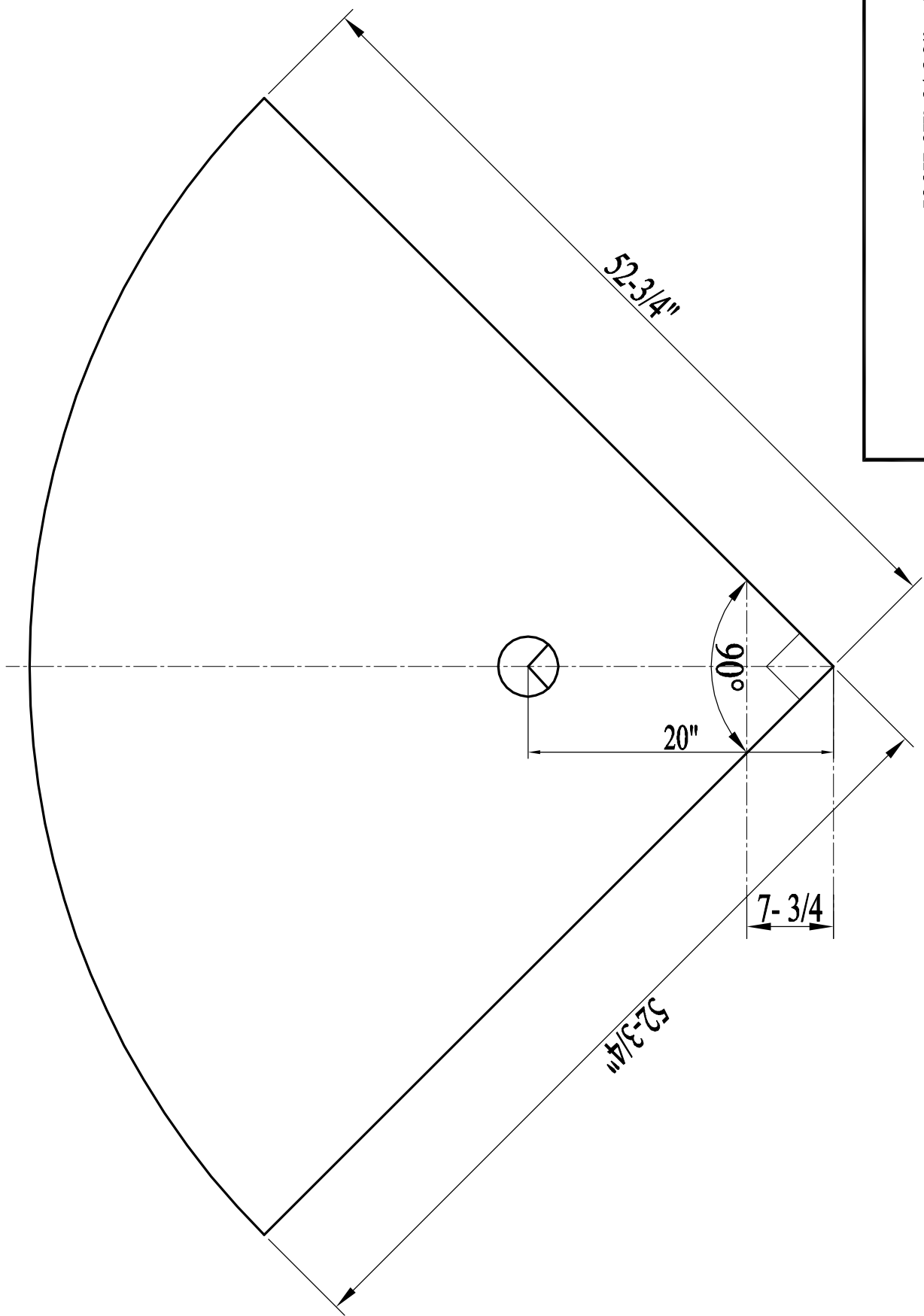

S-1605

A.H.Funrico.Inc